



CRYSTAL  
INSTRUMENTS

# VIBRATION CONTROL SYSTEMS

---

[WWW.CRYSTALINSTRUMENTS.COM](http://WWW.CRYSTALINSTRUMENTS.COM)



## Vibration Control Systems - Hardware Platforms

[www.crystalinstruments.com/vibration-test-controllers](http://www.crystalinstruments.com/vibration-test-controllers)



*Spider-81 Premium Vibration Controller*



*Spider-81B Basic Vibration Controller*

### Spider-81

The Spider-81 is the flagship model of Crystal Instruments vibration controllers. This 4th generation hardware is highly modular, distributed and scalable. Each Spider-81 has 8 analog input and 4 analog output channels. Eight digital I/O pairs are provided for custom applications. A bright front panel LCD displays the system status and test information. Users can instantly view real-time status information such as control RMS or sweeping frequency on the LCD panel.

The Spider-81 not only uses Ethernet for data communication, it goes further by employing IEEE 1588v2 time-synchronized Ethernet connectivity. This technology allows (up to 100 meters in distance) remote input modules to be connected solely by Ethernet (with no dedicated “sync” cable required), while still provides sampling and triggering synchronization within an accuracy of 50 ns. The Spider-HUB industrial Ethernet switch can expand the Spider-81 controller up to 512 input channels. All input channels across the system are amplitude matched within 0.1 dB and phase matched within 1° over a 20 kHz bandwidth.

All Spider front-ends contain a 4 GB flash memory for the storage of data and test processing instructions. If longer recording is required, the Spider-NAS (Network Attached Storage) provides 250 GB of solid-state disk (SSD) storage (extendable up to 2 TB) in a removable SATA cartridge. One Spider-NAS records streamed time waveforms for up to eight Spider front-ends at the same speed of 102.4 kHz per channel.

### Spider-81B Economical Vibration Controller

The Spider-81B front-end is a smaller, simplified system providing everything needed to run Sine, Random or Shock tests, measuring the control, and up to 3 monitor signals. This basic system offers a very comprehensive facility with the same control quality, safety assurance, measurement precision, expandability and human interface that distinguishes all Crystal Instruments controllers.



*Shown here are the Spider-HUB, the Spider-NAS, and Spider-80X.*



*The Spider-80X is designed for vibration control, machine monitoring, and data acquisition.*



*The Spider-80Xi is a compact, lightweight, high channel count data acquisition system intended for portable field use.*



*The Spider-80M is dedicated to MIMO control and MIMO structural testing applications.*

### **Spider-80X**

The Spider-80X is a compact package designed for applications in three fields: dynamic data acquisition, vibration control, and machine monitoring. It features eight analog input channels and two channels that can be software selected as analog outputs for vibration control or tachometer inputs for the analysis of rotating machinery. Spider-80X is the most compact form factor in the Spider series.

### **Spider-80Xi Hardware Platform**

The Spider-80Xi is a platform supporting all-purpose data acquisition. Featuring a 64-channel chassis weighing less than 10.5 kg, Single chassis can be carried in one hand and is optimal for field environmental testing where portability is essential.

The Spider-80Xi system consisting of one 64-channel chassis is AC powered at 100 to 240 V. The Spider-80Xi system consisting of one 32-channel chassis is DC powered at 10 V to 22 V. The latter is easily operable with the Spider-Battery (an external battery pack developed by Crystal Instruments) for further portability and acquiring data up to 4 hours without interruption.

Spider-80Xi platforms can host various front-ends including voltage, IEPE, strain, temperature or charge mode. Multiple Spider-80Xi chassis can combine to create a system with up to 512 channels, all simultaneously sampled and synchronized in excellent phase match between all channels, either on the same front-end or across front-ends, or even across multiple chassis.

The Spider-80Xi is ideal for the customers requiring a high channel count system with complete solutions for modal testing, vibration control, data acquisition and dynamic signal measurement.

### **Spider-80M Hardware Platform**

The Spider-80M platform is based on the efficient Spider-80Xi architecture and is dedicated to MIMO VCS control and MIMO structural testing applications. Each Spider-80M chassis features 8 outputs capable of carrying out 6-degree of freedom MIMO testing. One Spider-80M chassis and multiple Spider-80Xi chassis can chain together to form a very large system with up to 504 input channels.

Hardware Platform	Spider-81	Spider-81B	Spider-80X	Spider-80Xi	Spider-80M
<b>Application</b>	VCS, DSA*	VCS, DSA*	VCS, DSA, EMA*	VCS, DSA, EMA*	MIMO VCS, MIMO FRF*
<b>Number of Front-ends Per Chassis</b>	1	1	1	8	7
<b>Number of Inputs per Front-end</b>	8	4	8	8	8
<b>Max Number of Inputs Per Chassis</b>	8	4	8	64	56
<b>Max Number of Inputs Per System</b>	512	4	512	512	504
<b>Number of Outputs Per System</b>	4	1	2	2	8
<b>Input Mode</b>	Charge TEDS IEPE Voltage	Charge TEDS IEPE Voltage	Charge (optional) TEDS IEPE Voltage	TEDS IEPE Voltage Strain gage MEMS RTD Thermocouple	TEDS IEPE Voltage Strain gage MEMS RTD Thermocouple
<b>Digital I/O</b>	8 in/out, isolated	4 in/out, isolated	4 in/out, isolated	2 in/out, isolated	2 in/out, isolated
<b>Front Panel LCD</b>	Yes	No	No	Yes	Yes
<b>High Speed Data Port</b>	Yes	No	Yes	Yes	Yes
<b>Notes</b>	Flagship product for VCS line. Input protection up to 250 V. Equipped with Stop/Start button.	Economical solution	Modular at box level.	Modular at board level.  Input Mode depends on front-end type. See the following table.	Modular at board level.  Input Mode depends on front-end type. See the following table.



\* VCS = Vibration Control System



\* DSA = Dynamic Signal Analyzer



\* EMA = Experimental Modal Analysis



\* MIMO VCS = Multi-input Multi-output Vibration Control System

\* MIMO FRF = Multi-input Multi-output FRF analysis in EMA



**The Front-ends of the Spider-80Xi and Spider-80M Platform**

Front-end Types	Spider-80Xi	Spider-80Hi	Spider-80Ci	Spider-80SGi	Spider-80Ti
<b>Max Sampling Rate</b>	102.4 kHz	256 kHz	256 kHz	102.4 kHz	1 kHz
<b>Number of Inputs Per Front-end</b>	8	8	8	8	16
<b>Connector Type</b>	BNC	BNC	BNC	LEMO	Screwed terminal
<b>Input Type</b>	IEPE Voltage TEDS	IEPE Voltage TEDS	IEPE Voltage TEDS Charge	Voltage Strain gage Strain gage-based sensors MEMS DC-based sensors IEPE	3-wire RTD K type thermocouple
<b>Input Coupling</b>	AC Differential DC Differential AC Single-ended DC Single-ended	AC Differential DC Differential AC Single-ended DC Single-ended	AC Single-ended DC Single-ended	AC Differential DC Differential Bridge-Based Sensor In-line Charge Amplifier	PT 100 (RTD) K-Type input (TC)
<b>Sensor Excitation</b>	4.2 mA at 21 V for IEPE	4.2 mA at 21 V for IEPE	4.2 mA at 21 V for IEPE	2.5 V, 5 V, 10 V V for IEPE	10 $\mu$ A to 1.5 mA RTD
<b>Strain Gage Type</b>	-----	-----	-----	Quarter Bridge Type I, II Half Bridge Type I, II Full Bridge Type I, II Excitation voltage: $\pm 2.5$ , $\pm 5$	
<b>Max Input Range</b>	$\pm 20 V_{pk}$	$\pm 20 V_{pk}$	$\pm 20 V_{pk}$	$\pm 10 V$	400 Ohm (RTD) $\pm 80 mV$ (TC)
<b>Input Protection Voltage</b>	$\pm 220 V$	$\pm 220 V$	$\pm 220 V$	$\pm 40 V$	-----
<b>Analog to Digital Converter Per Channel</b>	Dual 24-bit ADC	Dual 24-bit ADC	Dual 24-bit ADC	24-bit ADC	24-bit ADC
<b>Cross Talk</b>	< -100 dB	< -100 dB	< -100 dB	< -100 dB	-----
<b>Amplitude Accuracy</b>	$\pm 0.1\%$ at 1 kHz 1 V	$\pm 0.1\%$ at 1 kHz 1 V	$\pm 0.1\%$ at 1 kHz 1 V	$\pm 0.1\%$	-----
<b>Phase Match</b>	< 1° up to 20 kHz	< 1° up to 20 kHz	< 1° up to 20 kHz	< 1° up to 20 kHz	-----

## Combined Environmental Testing

[www.crystalinstruments.com/temperature-humidity-environmental-controller](http://www.crystalinstruments.com/temperature-humidity-environmental-controller)

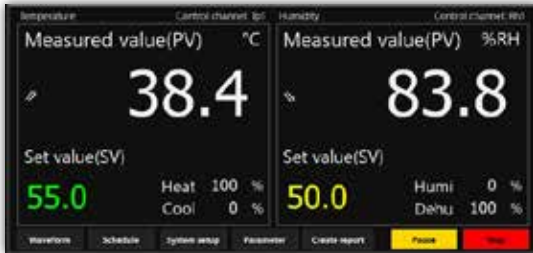

*Test status page of EDC on a wireless, touchscreen terminal*

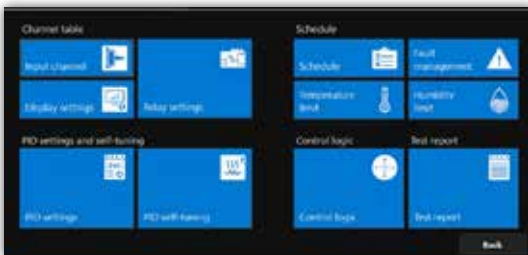

*Parameter page of EDC on a wireless, touchscreen terminal*



*Temperature & humidity signals are displayed on the same screen*

Test name	Create time	Test type	Size
Test1	Sep 20 2018 16:13:28	Temperature	100.0MB
Test2	Sep 25 2018 16:17:19	Test	100.0MB
Test3	Oct 16 2018 16:23:26	Programmed	100.0MB
Test1234	Mar 24 2020 17:42:56	Test	100.0MB
Test56789	Feb 13 2018 17:31:31	Test	100.0MB
Test abc	Aug 12 2020 13:42:14	Test	100.0MB
Test10000	Aug 10 2020 16:25:15	Programmed	100.0MB

Buttons at the bottom: Refresh, Delete, Delete page, Report, Export, View Schedule, Back, Open.

*Run log page of EDC on a wireless, touchscreen terminal*

The industry trend demands environmental testing conducted in fully integrated environments. Various physical parameters, including vibration (acceleration, velocity and displacement), temperature, humidity, pressure, torque, and electrical signals such as those from CAN bus should be monitored and controlled by one system. Crystal Instruments made dedicated efforts to achieve this goal.

Using the Ethernet network and PTP time synchronization technology, all Spider hardware devices connected to the LAN can be accessed and configured as one integrated system.

The Spider-101i is specifically designed to perform tests subjecting the DUT to simultaneous temperature cycling and variable humidity. The Spider-101i controls both temperature and humidity in a chamber system, which includes external heating/cooling and humidification/dehumidification systems.

When vibration control is required along with temperature and humidity control, it offers a lot of advantages and convenience to access the parameter and schedule setup between all combined physical quantities from one fully integrated user interface. If a THV (temperature, humidity, vibration) system (chamber + shaker) is equipped with a Spider-101i controller, the controller software allows the addition of a Spider vibration controller and operates the two systems as one while providing an integrated user interface. Users can execute vibration tests such as Random, Sine, Shock, SoR, RoR, and other types together with various cycle settings of temperature and humidity.

- One integrated setup
- One clock and schedule
- One user interface
- One testing report
- One vendor to provide technical support



*Temperature and Humidity Chamber with a shaker system*

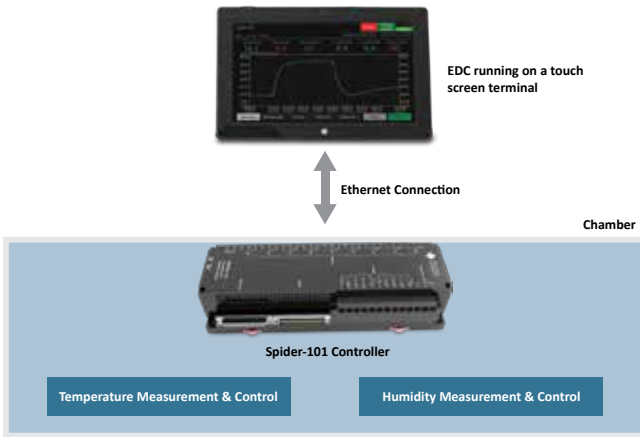

### SOFTWARE ADVANTAGES

- Both temperature and humidity can be display on the same plot
- Both Y-axis (temperature and humidity) can be zoom in/out to provide display in detail
- Live Display – display the latest data of the specific duration (x-axis)
- History View – display data of the entire test duration and zoom into any part of the test during operation (x-axis)
- Two cursors can be placed and show delta X and delta Y
- Historical data review on the panel directly
- Fault history and diagnosis with solutions provided
- Report automatically generated at the end of the test
- Customizable contents
- Zoom into screenshots of temperature holding in test
- Supports letter and A4 layouts; supports Word and PDF formats
- Easy to back-up all chamber configuration files
- Easy to download historical data, with or without all chamber configuration files
- Import and view data files or all configurations without connected hardware
- Third-party extension support

**Software Designed for Combined Environmental Testing**  
**EDC** (Embedded Device Controller) and **EDM THV** are two software modules specifically designed for the Spider-101i to perform Temperature/Humidity (TH) or Temperature, Humidity, and Vibration (THV) control tests.

**EDC** is a lightweight Windows application with an interface designed for touchscreen use. It runs smoothly on both Windows 10 computers and tablets, which can serve as mobile or fixed operation terminals that users can move freely or mount to the testing chamber. In addition, there is a wide selection of Windows tablets offered in the market that fulfill various requirements (such as the IP6X tablet). The Spider-101i controller runs on EDC software to conduct TH testing (without vibration) in independent climate chambers. Users can configure a test, operate a test, review test logs, review signals, and generate reports from the EDC interface.

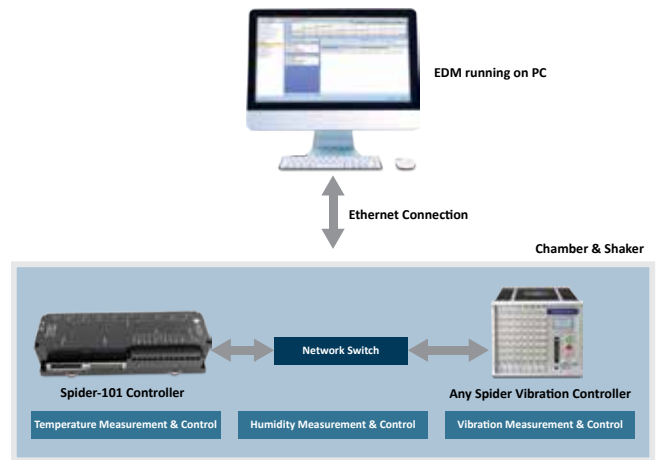

EDM THV is the THV control software application included in EDM (a PC-based software developed by Crystal Instruments). Use EDM THV with a Spider-101i and a Spider vibration controller when vibration control is required along with temperature and humidity control. EDM THV is a premium and full-featured software product as well as EDM VCS (Vibration Control System) and EDM DSA (Dynamic Signal Analyzer).

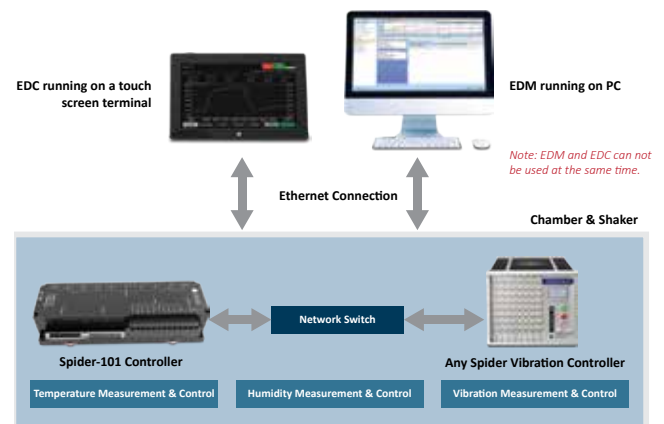

When EDM THV is running as the THV control software, EDC can be used to monitor the chamber status.

## Temperature Measurement in Vibration Testing

[www.crystalinstruments.com/spider80ti-temperature-measurement](http://www.crystalinstruments.com/spider80ti-temperature-measurement)



*Spider-80Ti Setup*



*Multi-module Setup*

The Spider-80Ti is a front-end from the Spider-80Xi hardware platform that adds 16 temperature measurement channels to a Spider-80Xi system, which can be a vibration controller system or a part of a vibration controller system.

Spider-80Ti is equipped with a 24-bit Sigma-Delta Analog to Digital Converter (ADC) per channel to ensure highly accurate temperature measurements with any type of sensor. Together with the user-configurable non-linearity correction, the accuracy of the measurements is ensured over a wide range of temperature measurements.

The Spider-80Xi chassis can either be configured exclusively for temperature measurements using the Spider-80Ti front-end or can be configured for mixed signal data acquisition by combining the Spider-80Ti with Spider-80Hi, Spider-80Ci, or Spider-80SGi.

Multiple chassis consisting Spider-80Ti front-ends or a combination of Spider-80Ti, Spider-80Hi, Spider-80Ci, or Spider-80SGi can be chained together to form a system with up to 1024 channels, all sampled simultaneously.

### **Selection of Temperature Sensors**

Each Spider-80Ti front-end is user-configurable to support either a PT100 RTD sensor or a K-type Thermocouple. A combination of RTDs and thermocouples within the same Spider system can also be achieved by combining the front-ends configured as RTDs and Thermocouples and makes it ideal for temperature measurements.

### **RTD Non-Linearity Correction**

To provide high accuracy during measurements the Spider-80Ti directly implements the IEC 751 RTD equations, the user can choose to use the coefficient values as defined by the standard or specify custom coefficients. Having these customizable coefficients also allows the user to use RTD sensors with different alpha values and greatly improves the accuracy of the measurements.

### **K-type thermocouple Cold Junction Compensation**

Thermocouples have two junctions, namely the Hot and Cold Junction. The hot junction is the measurement junction and is attached to the measurement point. In theory, the cold junction should be maintained at 0° C. As this is not a practical solution the cold junction is connected to an Isothermal block, the temperature of this block is measured by a high precision internal temperature sensor.

The thermoelectric voltage across the sensor is measured. The internal sensor measures the isothermal temperature, this is then converted to its corresponding voltage value. This value is used to offset the cold junction temperature to provide an accurate measurement.

### **Multi-point Sensor Correction**

The Spider-80Ti system allows the user to perform multi-point correction if the user has more precise values for the sensor, this data can be entered into the system to provide a linearized offset correction between the temperature breakpoints.



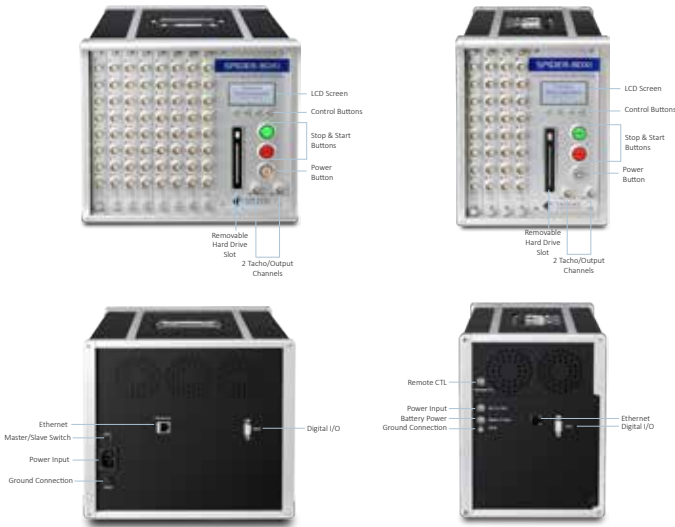

## Deploying Spiders as a Shutdown Protection System

Spiders are reputed as excellent products for vibration control applications. The vibration control system typically runs the control algorithms and takes several milliseconds to respond when an abort condition is encountered. The reaction time to shut down the drive may cause severe damage to the Device Under Test (DUT). To protect the DUT, a redundant shutdown protection system must be employed to continuously monitor the abort conditions and to abort the shaker/amplifier or the vibration control system within a small fraction of time.

The Spider platform of products can now provide redundant shutdown protection of a shaker system that is running a valuable DUT. The shutdown is achieved in under 10 ms for single module systems and under 20 ms for high channel count systems.

In addition, the Spider system can be attached as a redundant system to any of the current vibration control systems.

Users can define limits for raw time domain signals, RMS time signals, and frequency signals to trigger abort signals.

Event Capture (called Run Log on EDM) keeps track of all the events encountered on the Spider including the time and specific details of the event.

- Captures the time at which alarm is triggered
- Captures the channels for which alarms have triggered
- Captures the time and details of all other events

Channel Status on the other hand gives the status of all the channels in one display. Errors caused on any channel can be easily detected using the Channel Status. It is easy to identify which channel generated an error or triggered an alarm.

### KEY FEATURES FOR SHUTDOWN PROTECTION:

- User selectable input channel for COLA input signal
- Customizable bandwidth tracking filters
- Customizable Alarms (raw time/rms time/frequency domain)
- Digital output signal based on alarm results
- Run log event capture
- Powerful Black Box Mode
- IEEE 1588-time synchronization between front-end modules (50 ns time sync accuracy)
- Measurement dynamic range up to 160 dB
- Frequency resolution as fine as 0.001 Hz
- Measurement strategy: tracking filter, RMS, Mean, peak
- Total time between the onset of an alarm to the change in the state of the digital output: < 10 ms for system no more than 8 channels and <20 ms for more than 8 channels

### KEY FEATURES FOR DATA RECORDING:

- Continuously record raw time data for all input channels (up to 512 inputs)
- Storage of continuous recording is up to 16 TB (2 TB per 64 channels)
- IEEE 1588-time synchronization between front-end modules (50 ns time sync accuracy)
- Processed by EDM Post Analysis software

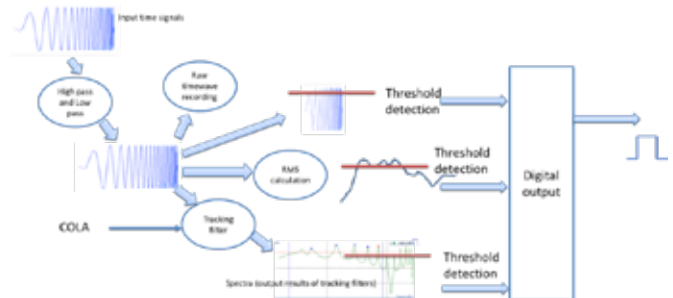

## Strain Gage Measurement in Vibration Testing

[www.crystalinstruments.com/spider80sg-general-data-acquisition-with-strain-gage](http://www.crystalinstruments.com/spider80sg-general-data-acquisition-with-strain-gage)

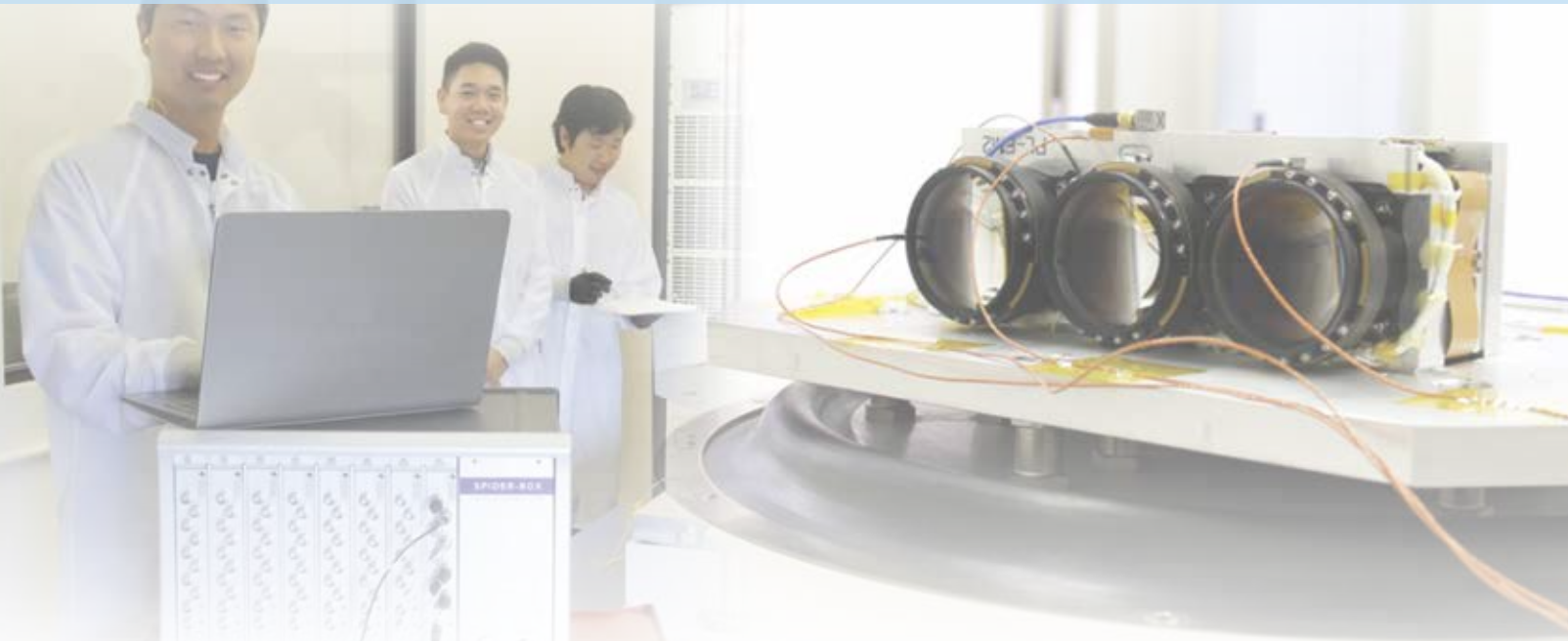

*The Spider-80SG Strain Gage Measurement System*



*Spider-80SGi in the Spider-80M platform*

### **The Spider-80SG Strain Gage Module**

The Spider-80SG/SGi is a front-end in the Spider-80X/Xi hardware family platform. It is a high precision, general purpose data acquisition device featuring strain gage functionality. This device can be used in a variety of physical and measurement tests.

The Spider-80SG can acquire data from a strain gage or a wide range of sensors. With the help of precision excitation voltage, the Spider-80SG/SGi can support strain gage based sensors, MEMS sensors, IEPE and DC sensors (to name a few) thus expanding the scope of the Spider-80Xi hardware platform to support the synchronized acquisition of a wide range of measurement quantities including Force, Torque, Pressure, Acceleration, Velocity and Displacement. It can be used for strain measurement and many other types of sensors that requires external power. EDM-DSA and VCS software fully supports the Spider-80SG front-end in all its testing operations.

In addition to the features shared with the Spider-80Xi hardware platform, the Spider-80SG/SGi offers the following capabilities.

### **High Channel Count**

Named for their networkable ability, the Spider hardware platforms (including the Spider-80X/Xi and the Spider-80SG/SGi) share the flexibility of scaling up in channel count and functionality. The Spider-80SG/SGi can combine with any Spider-80Xi device to create a high channel count system with up to 512 channels to perform data acquisition during vibration tests in a vibration control system.

## Spider-80SG

### Highlighted Features:

- 8 strain gage/general purpose inputs per front-end
- 24-bit ADC channel
- Supports multiple measurement quantities
- Supports Quarter Bridge, Half Bridge and Full Bridge and Rosette strain gage configurations
- Supports a variety of strain gages based sensors, load cells, pressure transducers, torque sensors, LVDTs, MEMS accelerometers, displacement sensors, velocity transducers and geophones and IEPE sensors
- User configurable synchronized sampling rate
- Remote sensing: measures strain accurately from up to 1000 ft cable length with up to 10 KHz frequency.
- Precision excitation voltage of  $\pm 2.5$  V and  $\pm 5$  V
- Power supply voltage of 2.5 V, 5 V and 10 V for sensor excitation
- Shunt calibration
- Offset nulling for any measurement quantity
- Multiple trigger modes
- Compact, portable design
- Scale up to 512 channels using multiple front-ends
- User selectable sampling rate for each front-end in a high channel count system
- DC drift: less than  $1.5 \mu\text{V/V}$  in 48 hours

### Dual Modes of Excitation

The Spider-80SG is equipped with dual excitation modes. There is an option for Precision Excitation Voltage of  $\pm 2.5$  V or  $\pm 5$  V that can be used to excite a strain gage or a strain gage based sensor and to accurately measure the minute change in resistance. It is also equipped with a user configurable DC power supply of 2.5 V, 5 V and 10 V which can be used as an excitation voltage for a wide variety of sensors.

### Strain Measurement

The Spider-80SG/SGi supports Quarter Bridge, Half Bridge and Full Bridge configurations for each input channel. It also supports measuring strain through Rosette configurations by combining the user selected channels in the desired configuration.

### Remote Sensing

The Spider-80SG has been tested to work on strain gages up to 1000 ft away from the analyzer using the remote sensing feature. Using an 18 AWG 5 conductor cable to measure the excitation voltage using remote sensing and changes in output voltage, the error was measured to be less than 1.5% for signal frequencies up to 10 kHz.

### Measurements Quantities and Sensor Types

The Spider-80SG/SGi's user-selectable precision excitation voltage feature enables it to interact with a wide range of sensors, allowing the synchronized acquisition of a wide range of measurement quantities.

Supported Sensor Types: MEMS based Sensors, Strain gage based sensors, Precision Excitation DC Sensors, IEPE and In-line charge amplifiers

Supported Measurement Quantities: Force, Pressure, Torque, Acceleration, Displacement, Velocity, Sound Pressure.



**Spider-HUB Industrial Ethernet Switch**



**Spider-NAS Storage Device**

Spider systems use superior Ethernet and time synchronization technology developed by Crystal Instruments which allows modular expansion to support up to 512 input channels. When a system is running with multiple front-ends totaling to hundreds of input channels, all data is simultaneously acquired and is accurately phase matched. The phase match accuracy can be less than 1 degree within the normal testing frequency range. By providing such high phase match, the frequency response function of cross channel measurement can be used for analyzing the characteristics of the UUT (unit under test), such as modal shape and damping ratio.

In a Swept Sine test that runs hundreds of input channels, the tracking filter and notching can be applied to any of input channels. In a Random or Sine-On-Random control test, the limiting can be simultaneously applied to all input channels. In TTH or Shock, all data captured across all channels is acquired simultaneously. The CI Spider system is the only product in the world that fully integrates dynamic signal measurement, modal data acquisition and vibration control functions across up to 512 channels.

Aside from saving the signals to PC, data recording on the Spider systems can be realized via either of two approaches: (1) record the time-stream data into the flash memory on each of Spider front-end or (2) record the time-stream data into an external storage device such as the Spider-NAS.

The Spider-NAS can store simultaneous data from all (64 maximum) attached dynamic measurement channels at a sample rate as high as 256 kHz, or as low as a few samples per second. The default capacity of the SSD is 250 GB and is extendable up to 2 TB. If a system has more than 64 channels, every 64 channels will require one Spider-NAS.

**Spider-80Xi System (512 Channel Count)**

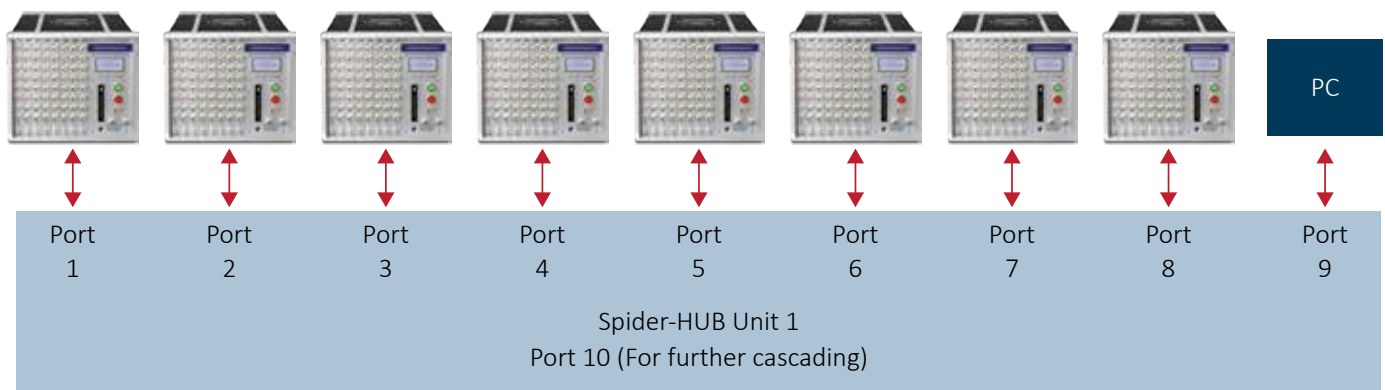

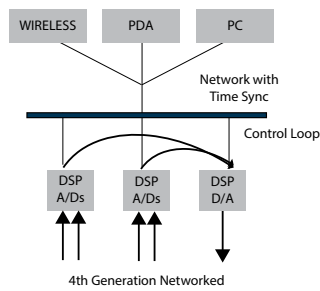
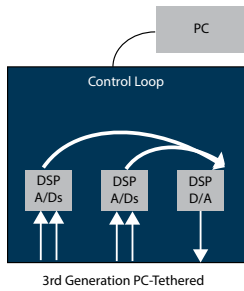
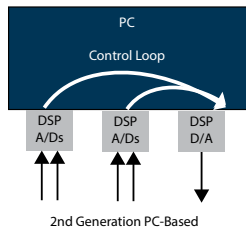
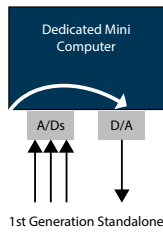

**The Spider platform is based on a fourth generation DSP centralized architecture.**

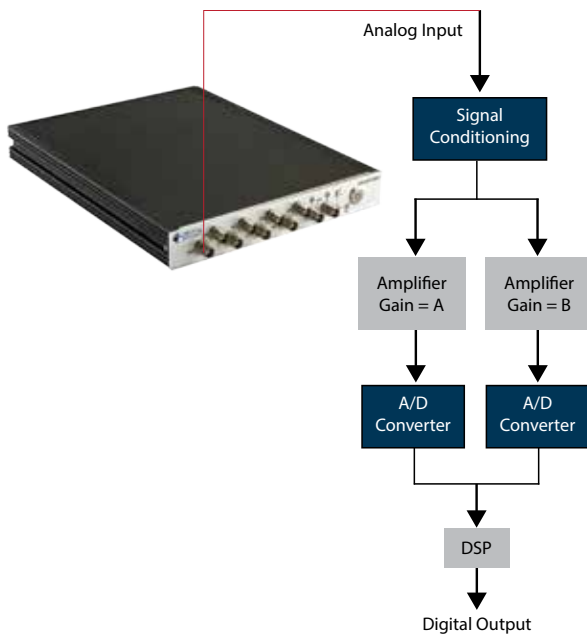

**Hardware per US Patent 7,302,354 applies two ADCs to each input channel.**

## Vibration Control Systems - Unique Features

### Latest Hardware Design

The Spider front-ends have voltage, IEPE and charge inputs which are ideal for shock, vibration, and acoustic measurement, strain or general-purpose voltage measurement. The internal flash memory stores test configuration data for controlling up to hundreds of channels simultaneously and stores real-time analysis data. Multiple output channels provide various signal output waveforms that are synchronized with the input sampling rate. Ten monitoring connections on each unit are used to read analog input and output signals. There is a built-in isolated digital I/O to interface with other hardware. Our scalable architecture allows users to employ as many as 512 input channels for the utmost spatial resolution. Sampling to 256 kHz provides excellent time resolution while spectra with up to 25,600 lines may be controlled in Random. Data is stored into 4 GB of internal flash memory. Increased storage space is possible with the addition of a 2 TB external disk. Input channels are protected against transient interference of up to 220 V.

### Vibration and Various Data Acquisition Inputs

The CI Spider series supports a wide range of measurement types including vibration acceleration, displacement, velocity, strain, temperature, humidity, tachometer, torque, force, charge, current and more. A wide range of compatible sensors can be selected with the Spider hardware.

### Shaker Compatibility

Spider controllers work with any electrodynamic, servo-hydraulic, or servo-electric shaker with all ranges of force ratings, from tiny desktop to multi-ton water cooled systems. Frequency range can be from sub 1 Hz to 40 kHz. MIMO controllers can drive complex shaker systems with multiple actuators. MIMO controllers can drive complex shaker systems with multiple actuators.

### Designed for High Precision and Accuracy

The Spider analog input channels provide extremely high precision measurements. Each channel has single-ended or differential AC or DC input coupling. It can also provide IEPE (ICPTM) input mode (AC coupling with a 4 mA constant current from a 24 VDC source) for use with industry-standard accelerometers with built-in amplifiers. The ability to read TEDS (Transducer Electronic Data Sheet) identification from the attached transducer completes the channel's compliance with IEEE 1451.4.

In some models, built-in charge amplifiers are available. For pyrotechnic and other high-shock applications or tests involving very high DUT temperatures, each input channel can accept a charge-mode piezoelectric sensor input directly without using an expensive external charge amplifier.

Using our patented parallel dual analog-to-digital converter (ADC) design (U.S. Patent Number 7,302,354), each measurement channel provides an unprecedented dynamic range of 160 dBFS (v7.7 and later) and can detect signals as small as 600 nV and as large as 20 V. This design eliminates the need for the input range or gain settings found on traditional controllers.

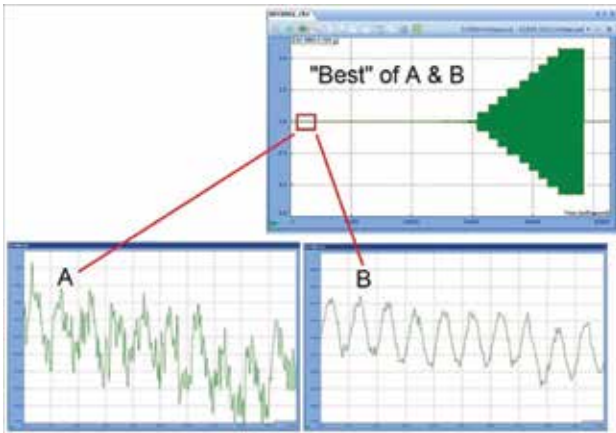

*DSP knows how to pick the data from either A or B path, and “stitch” them together.*



### Simple Network Connection

Ethernet connectivity allows Spiders to be located far from their host PC. This distributed structure greatly reduces noise and electrical interference in the system. A single PC can monitor and control multiple controllers over a network. Since the control processing and data recording are executed locally inside the controller, the network connection does not affect control reliability. With wireless network routers, a PC connects easily to the Spiders remotely via Wi-Fi.

### Time Synchronization between Multiple Hardware Front-ends with only Ethernet Cable

The Spider is built on IEEE 1588 Precision Time Protocol (PTP) time synchronization technology. Spider modules on the same network can be synchronized within 50 ns accuracy, which guarantees  $\pm 1^\circ$  cross-channel phase match up to 20 kHz across the complete system. With this unique technology and high-speed Ethernet data transfer, the distributed components on the network truly act as one integrated system.

### Black Box Mode

Black Box mode enables Spider operation without a PC. In this mode, a PC is used only to configure the control system before the system starts operation and to download data after the test is completed. During the test, the controller operates autonomously, according to a preset schedule.

### LCD Display

The Spider-81, Spider-80Xi and Spider-80M are equipped with a bright front-panel LCD and intuitive information navigation controls. Real-time status such as control RMS or sweeping frequency can be viewed live on the LCD display. IP network settings are also viewable on the LCD display to help connect the Spider systems to the PC.

### Designed for High Reliability

The Spider is the very first vibration control system designed for fail-safe operation even in the event of network or power loss. Advanced safety routines allow sensor failures to be detected within milliseconds. All Spider hardware pass strict environmental tests including EMI, temperature, drop shock, sine and random vibration. The system is built to withstand the rigors of the testing environment with long-lasting durability. The unique floating ground design reduces ground loop problems typically found in testing laboratories. Power backup circuitry based on a super-capacitor is installed to handle any disastrous power loss.

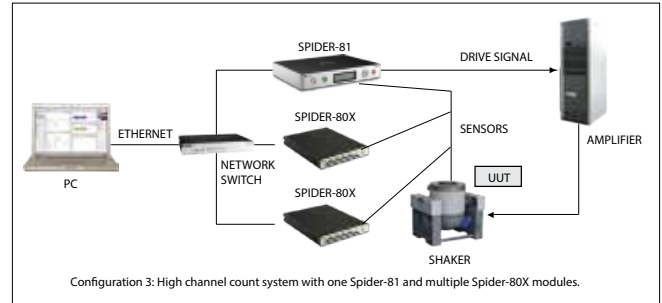
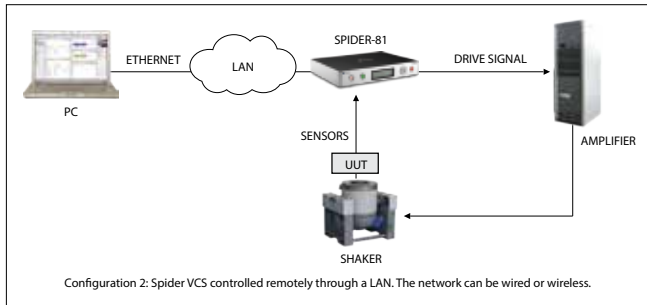
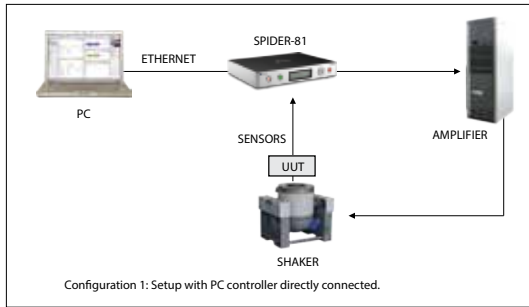

### Designed for High Performance Control

By using enhanced control algorithms and a simplified DSP architecture, the feedback loop time of Sine and Random control are greatly reduced to a 10 ms latency. Reduced control loop time improves performance for resonance search and tighter control for a structure with high-Q resonances. It also provides faster adaptive responses for better safety protection.

### Ease of Use

The Spider software is further improved at the user interface level. More graphical guidance, wizards, and tools are available to simplify test setup. The interface has been reformatted to be more intuitive. Event-Action Rules, Abort-Sensitivity, and numerous other new concepts are introduced in the software to simplify operation. Keyword searching through a large number of tests is easy. A smart network detection tool makes hardware installation very simple.

### Admin and User Account Permissions

The controller software provides different account profiles with permissions that can be enabled or disabled (e.g., editing profiles, manually control of run level) to meet the user's role in the organization. An account with disabled features uses a cleaner interface that minimizes confusion.

### Variable Sampling Rate

Applications that require measuring several quantities (e.g., acceleration, strain, temperature) may have different requirements for the sampling rate. The Spider product line provides a variety of products that support mixed sampling rates for different quantity measurements.

### Cloud Enabled

Cloud service is provided at the customer's request. Test status, software version, hardware status and live data is displayed on the web browser. The data transmission between the controller software and cloud server is fully encrypted. Access Control and file sharing features are available.

### CAN Bus Alarm/Aborts

CAN bus data from the DUT now can be monitored by the controller software using a CI custom adapter. Alarm and abort limits can be applied to CAN bus data so that the controller software can stop/pause the vibration test when limits are exceeded. This feature can automate vibration tests by monitoring and reacting to the DUT status in real-time and can be a safety measure for battery testing.

### Online Visualization

This feature animates the DUT's deformation during a vibration test from real-time measurements. The animation is based on the 3D model (geometry) of the DUT, which can be imported from a FEA/CAD model or be constructed from a sequence of evenly spaced photos taken around the object with a tool included in the EDM software.

### Designed for High Scalability and Expandability

With the Spider architecture, it is possible to make the hardware system ultimately scalable and expandable. A testing lab that purchases multiple front-ends of the Spider-81 or Spider-80X can freely move around their units and configure their own systems. For example, if a user purchases 8 Spider-80X front-ends, the user can use it as a 64 channel system, or separate them into two systems each with 32 inputs, or even into eight systems to control eight shakers each with 8 inputs.



## Vibration Control Systems - Software Solutions

### A Wide Range of Software Functions in Vibration Control and Signal Analysis

The Crystal Instruments vibration control system (VCS) software is designed for a wide range of vibration and shock testing customers. The VCS software suites support Spider hardware systems with as few as two input channels to systems with up to 512 input channels and multiple drive output capabilities. Software solutions for vibration control includes Sine, Resonance Search Track & Dwell (RSTD), Oscillator, Random, Sine-on-Ransom (SoR), Random-on-Random (RoR), Swept Random-on-Random (SRoR), Classical Shock, Transient, Seismic, Shock Response Spectrum (SRS) Synthesis, Time Waveform Replication, Multi-sine, Sine Reduction, Crash Control, Transient Random, multi-shaker control and a range of MIMO control functions. The VCS software is fully integrated into the combined test environment which includes controls to temperature, humidity, pressure, strain, torque and other quantities.

The same Spider hardware running VCS also supports a wide range of dynamic data acquisition and real-time processing functions including Fast Fourier Transform (FFT), Frequency Response Function (FRF), real-time filters, octave and sound level meters, order tracking, automated limit testing, transducer calibration and a comprehensive suite of modal testing and analysis.

### Multi-Language Support

Crystal Instruments' EDM fully supports software interfaces in English, Japanese, Simplified Chinese, Traditional Chinese or Russian. The selected language can be changed without re-installing the software.

### Easy Network Configuration

Intelligence has been built into the software so that the hardware devices on the network can be detected and accessed with little effort. A Security Access Code (SAC) is used to protect unauthorized access to the hardware on the network.

### Multi-Tab and Multi-Screen Support

To support the high channel count system that may display up to hundreds of signals, the software is designed to support multiple tabs and multiple screens. The highly flexible online display capabilities are expandable, making monitoring high-channel count systems quicker and easier. Display layouts for each tab and screens can be set up and stored for rapid access.



**EDM (Engineering Data Management) is available in English, Japanese, Simplified Chinese, Traditional Chinese, and Russian.**



**Step 1:**  
EDM sets the alarm limit together with a special message string, such as "Exceeding Limit".

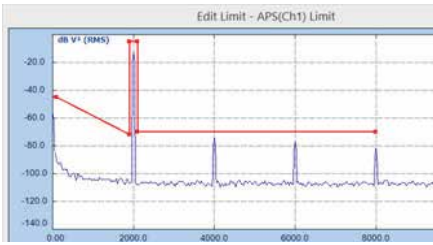

**Step 2:**  
When an alarm event happens, the customized string, "Exceeding Limit" will be sent to the EDM Cloud email service.



**Step 3:**  
User will receive an alarm email



### Safety First

Our software and hardware utilize many safety features to ensure reliable closed-loop vibration control – from pretest checks to abort checking, notching and controlled shutdown during a test. The check-only mode allows checking the connection of sensors and verifies the amplifier status before turning the drive output on. This pretest function is an extremely powerful tool for detecting possible set-up problems before your test is started. During closed-loop control the VCS software performs RMS and line-by-line abort checks, sigma clipping and drive limitation and continuously checks for open channels and overloads. The software carefully checks for open-loop conditions such as failure of a sensor connection and verifies proper response during the initial drive ramp-up. During every test, the shaker limits (peak acceleration, velocity, displacement), maximum drive voltage and sensor connection status are continuously monitored and will initiate an emergency shutdown in case of any deficiency.

### Multi-Tasking

With DSP centralized hardware architecture, the real-time measurement and control processes are all run on the front-end hardware; users can utilize all of the capabilities of the host computer for other tasks. This multi-tasking concept guarantees powerful and time efficient vibration testing, even with time critical tests. More importantly, it provides a unique and important safety feature: any computer or network failure will not affect the vibration control.

### Test Sequence

A Test Sequence provides the capability to automatically execute a sequence of tests. The user can Run, Pause or Stop the testing at any time and the software keeps a detailed log of the actions and results.

### Event-Action Rules

Event-Action Rules is a new way to customize the controller behavior. Many events that can occur during the course of test operation, including certain response levels being reached, limits being exceeded, and user events such as Pause or Stop. Event-Action Rules define the response of the controller to these test events. Many actions are available as custom responses, such as sending an e-mail, send a digital output signal to the climate chamber or stopping the test.

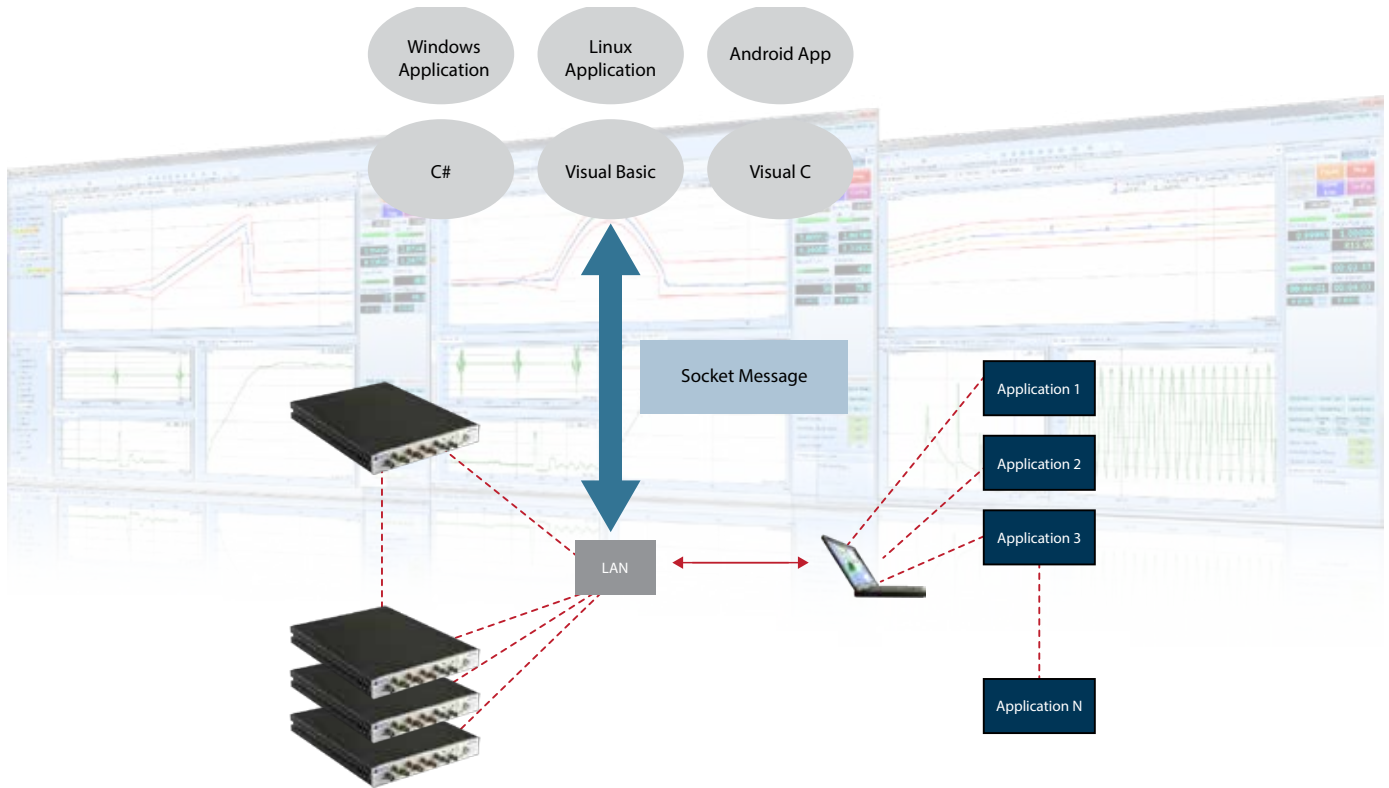

### Connectivity to Other Software, Hardware and You

Various approaches have been developed to establish the connectivity between the EDM software and other applications, such as climate chamber software or an amplifier controller. Socket messages, a common language that runs on nearly all operating systems and hardware platforms, is used to send and receive messages between EDM and other software. A digital input/output hardware interface is also provided on every Crystal Instruments product, which enables interfacing to other hardware devices. Test status reports can be sent via email or SMS text message to your mobile phone, enabling you to decide whether to return to work or not within minutes of the test stopping.

### Continuous Time Data Recording

The Spider platform is capable of recording the data of 512 control/monitor input channels sampled at up to 102.4 kHz. The storage can be either internal flash memory or a dedicated solid-state drive. The reliability of the software for such real-time data transfer has been fully validated. Continuous recording happens in parallel with vibration control and neither is affected by the other.

### Database Technology

By using latest database technology, EDM can quickly search, index and organize the testing setup and data. On the company network different testing stations can share the same database.

### Location ID and Customized Signal Labeling

In EDM, signals can be clearly labeled with names conveying physical meaning, such as "Top" or "Front". All related signals will be renamed with such labeling automatically.

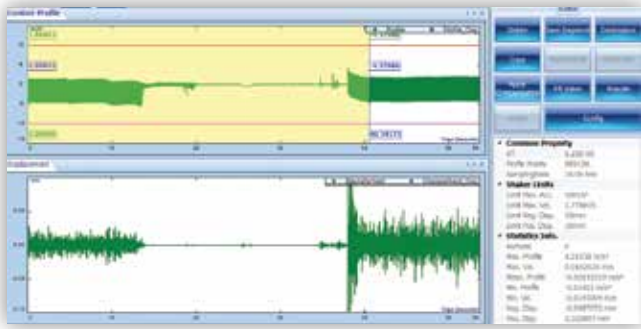

### Check List for the Initial Startup

EDM can show an overview of the critical parameters to be verified before a test is started.

### Flexible Math Function

EDM software provides flexible math functions to perform block arithmetic on signals using +, -, \*, / or other arithmetic operations. Math functions can be applied in both time and frequency domains.

### Non-Acceleration Measurements

Any input channel can measure any type of physical signal such as displacement, temperature or pressure.



### Remote Operation Communication Using Socket Messages

Socket messages allow communication with other software applications and hardware, such as temperature chambers. With the Socket Message protocol, Crystal Instruments' controller can be accessed from LabView, Matlab or other customized software running on Linux, MacOS, or Windows operating systems. Please refer to the Socket Message Specifications for further details.

### Shaker Parameters

Shaker parameters are saved to the library and used repeatedly in different tests. The library can be imported from or exported to a Microsoft Excel spreadsheet.

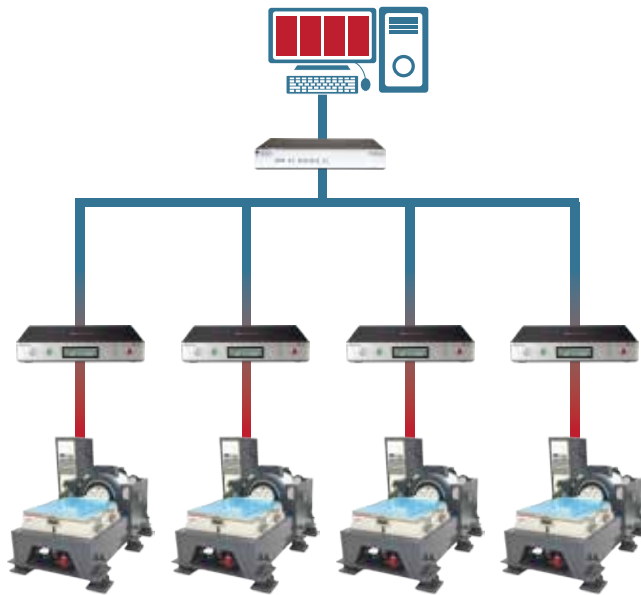

### Multiple VCS instances

Launch multiple EDM VCS instances on one computer. Each instance of full-featured VCS software connects to one controller that drives one shaker. Each instance runs the vibration control test individually. All instances may run different test types or the same test type. The operator performs the tests and monitors the test status from the same computer, where all reports and signals from multiple instances are saved to for better management.

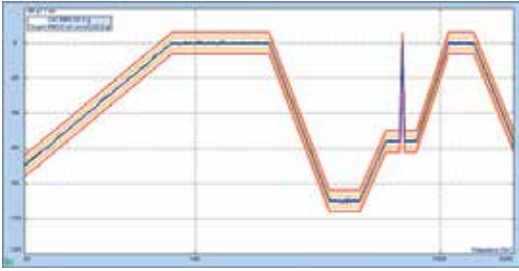

### Random Vibration Control

Random is the most popular type of excitation. Gaussian or non-Gaussian random signals are generated by the Spider controller to create a broadband excitation to the shaker. Feedback control signal meets most stringent requirements defined by aerospace or military testing standards. Input channels can be set as control, monitor, or limit.

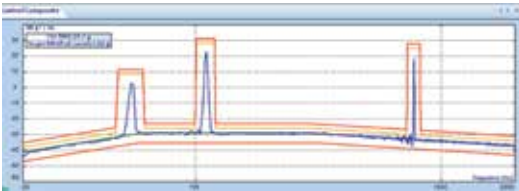

### Sine on Random Control

Up to 12 independently sweeping controlled sine tones may be added to the broadband random signal. Each sine tone has its own sweeping schedule and range. The sweep rate can be fixed or customized to better simulate real-world conditions. Tones can be turned on and off manually or by a predefined schedule. Multi-resolution spectrum technology allows for 8x finer frequency resolution in the lower frequency portion of the spectrum, improving control and display without sacrificing block size and response time.

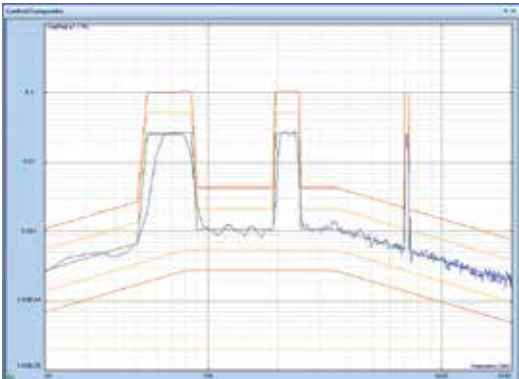

### Random on Random Control

Up to 12 independent (stationary or sweeping) random narrow-band signals may be superimposed on the broadband random signal. Each narrow-band has its own sweeping schedule and range. They can be turned on and off by a predefined schedule or manually.

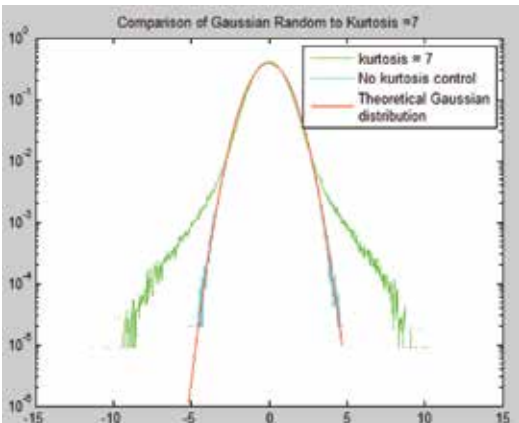

### Kurtosis Control & Drive Clipping

Kurtosis control can provide a more damaging non-Gaussian random control time history. A unique patented technology can generate a non-Gaussian control time history while precisely maintaining its spectrum shape.

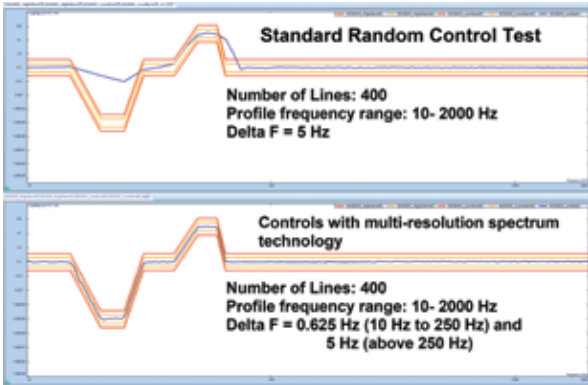

**Multi-Resolution Control**

The multi-resolution spectrum analysis developed at Crystal Instruments provides 8x finer frequency resolution in the lower portion of the spectrum. This technology maintains the benefits of a fast response time for detecting alarms and aborts while increasing the control accuracy and dynamic range. Supports Random, Sine-on-Random, Random-on-Random.

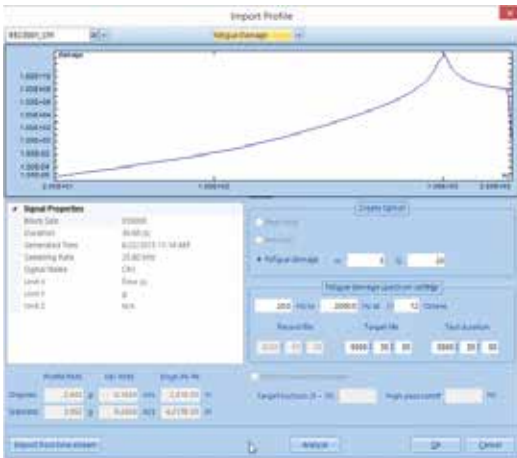

**Fatigue Damage Spectrum**

Fatigue Damage Spectrum (FDS) allows users to compare the potential damage caused by different Random and swept Sine profiles. In a similar fashion to Multi-Sine Control, FDS provides a way to reduce testing times by calculating the quickest path to destruction or damage. EDM can generate a Random PSD profile containing the same fatigue damage levels as the imported time stream and the profile can be adjusted so that the DUT is subject to the same amount of fatigue in the shortened test time compared to its expected lifetime.

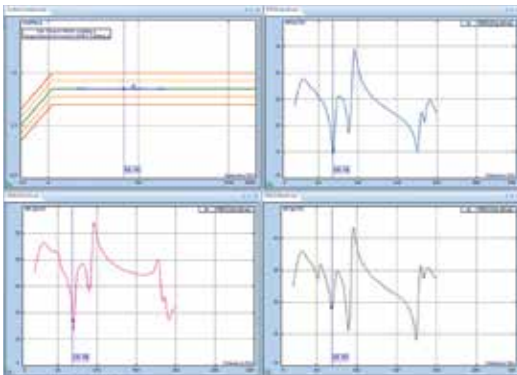

**Swept Sine Control**

Swept Sine Vibration Control provides precise real-time multi-channel control. It provides a spectrally pure and undistorted sine wave and a control dynamic range of up to 100 dB. As many as 512 channels can be enabled for control, notching, or monitoring, while supporting time-data recording.

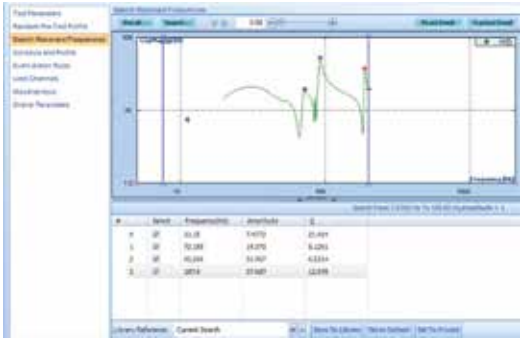

### Resonance Search and Tracked Dwell (RSTD) Control

The resonance search function determines resonant frequencies from the peaks of a transmissibility signal. Dwell type (Fixed dwell, Tracked dwell, Phase tracked dwell) may be specified manually (with a list of resonance frequencies) or automatically executed after a resonance search is done.

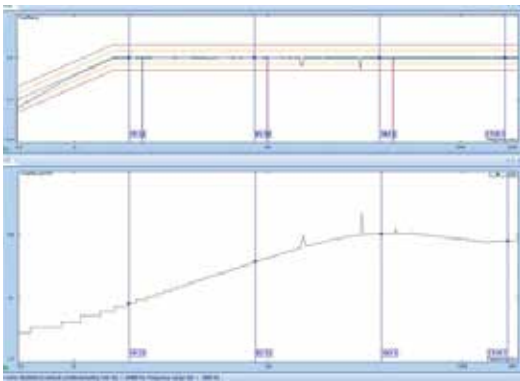

### Multi-Sine Control

Multi-Sine control enables multiple sine tones sweeping simultaneously and ensures that multiple resonant frequencies of the structure can be excited. With multiple sine tone excitation, the required time duration of sine testing can be reduced significantly.

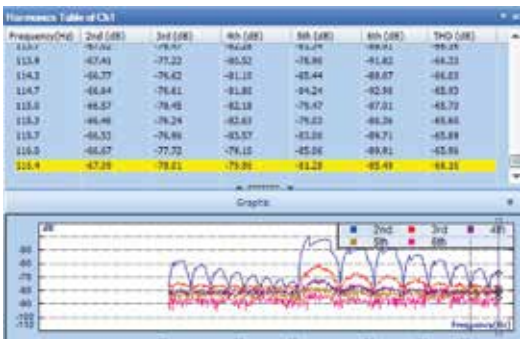

### Total Harmonic Distortion (THD) Measurement for Sine

This option adds the ability of computing Total Harmonic Distortion (THD) of the control and Input signals. THD plots can be generated while drive signal either steps through multiple discrete frequencies or a swept sine tone within a predefined range.

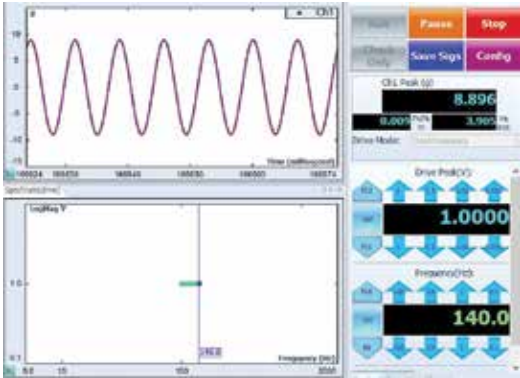

### Sine Oscillator

Sine Oscillator is a diagnostic tool providing manual control of the sine output while the system displays various time signals and frequency spectra. Random excitation can be enabled as a checkup function. When the close-loop option is enabled, the Sine Oscillator is essentially a limited sine controller with augmented manual control functions.

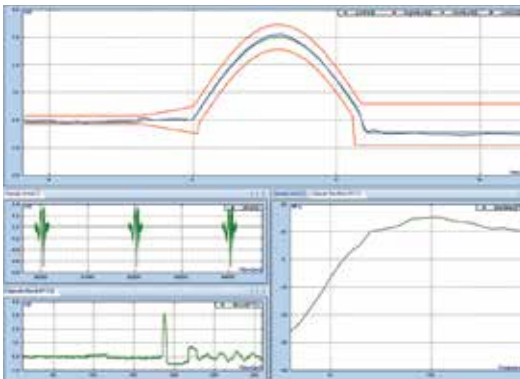

### Classical Shock Control

Classical Shock Control provides precise, real-time, multi-channel control and analysis of a transient motion in the time domain. Classical pulse shapes include half-sine, haversine, terminal-peak sawtooth, initial-peak saw tooth, triangle, rectangle, and trapezoid. Applicable Test Standards include MIL-STD-810F/G/H, MIL-STD-202F, ISO 9568 and IEC 60068 (plus user-defined specifications).

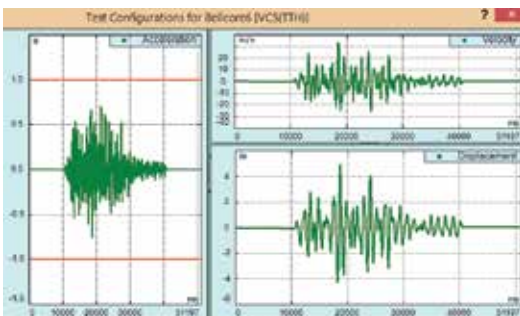

### Transient Time History Control (TTH)

Targeting seismic simulation applications, TTH controls shaker motion to match any user defined transient waveform. Time waveforms can be imported to EDM in various formats. Scaling, editing, digital re-sampling, high-pass or low-pass filtering and compensation will tailor the waveform so that it may be duplicated on a particular shaker.

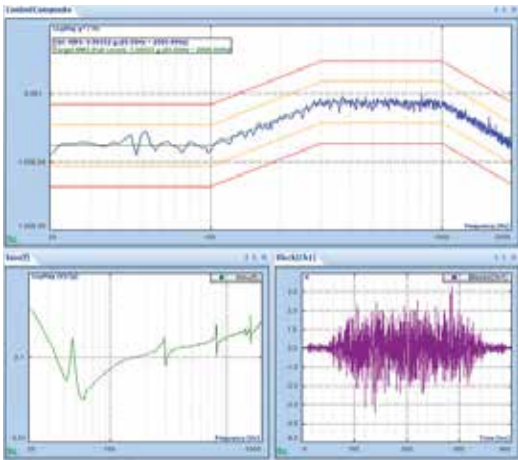

### Transient Random Control

Transient Random control applies a chain of pulses with random nature to the shaker. The target profile power spectrum is defined in a same way as Random control, with the addition of defining transient pulse interval. Applications includes gunfire simulation or road simulation.

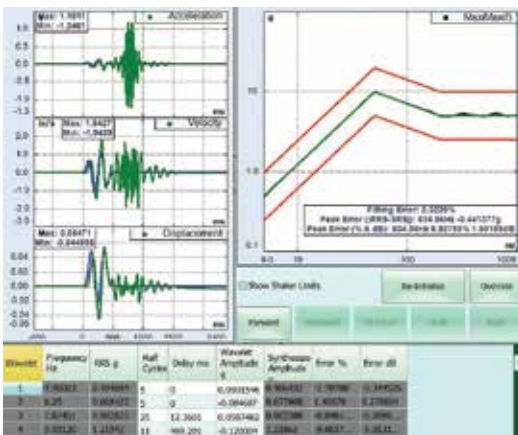

### Shock Response Spectrum (SRS) Synthesis & Control

The SRS synthesis and control package provides the means to control the measured SRS of the DUT to match a target SRS, the Required Response Spectrum (RRS). The necessary drive time history is synthesized from damped-sine or sine-beat wavelets. Damped Sine Parameters include frequency, amplitude, critical damping factor, and delay. Waveforms may be automatically synthesized from a user-specified SRS reference profile.

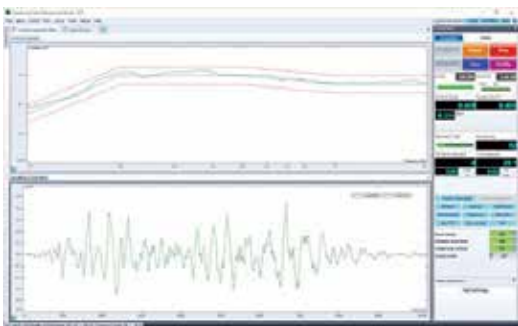

### Earthquake Testing Control

The earthquake testing control package provides controls to meet a target a Required Response Spectrum (RRS). Waveforms are automatically synthesized from a user-specified SRS reference profile using random type of wavelets, uniform or shaped. Alarm and Abort tolerances may be applied to any active channel to provide an extra degree of safety for delicate test articles.





### Time Waveform Replication

Time Waveform Replication (TWR) provides precise, real-time, multi-channel control for long duration waveform duplication. TWR includes the Waveform Editor, a flexible importing and editing tools for long waveform signals. The Recording option records time stream data at the full sample rate on all input channels.

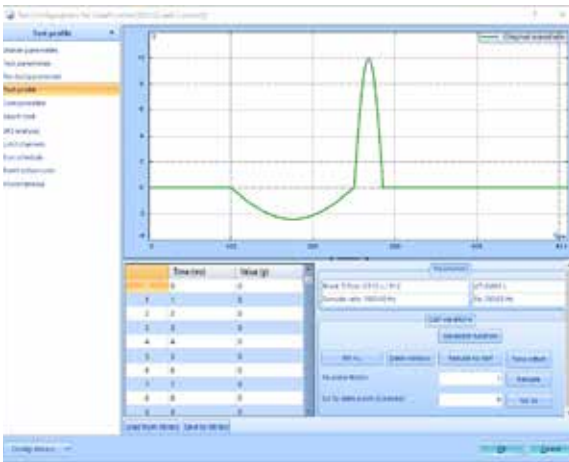

### Crash Control

The Crash Control is a specialized version of TTH catering to vehicular incident testing standards to simulate the conditions of a vehicle suddenly braking or crashing. It assumes a specialized long-displacement shaker is being used to run the vibration test. After each pulse, this special shaker armature ends up in a different ending displacement than starting position and can be adjusted back to neutral by the software.

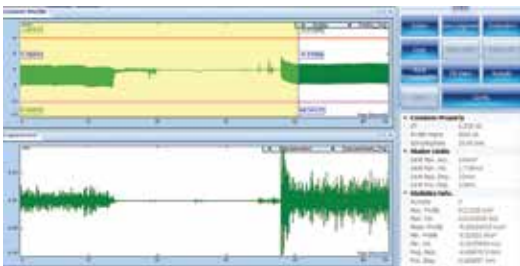

### Waveform Editor

**Profile Definition:** Any existing signal is treated as a profile and is imported and defined as a control.

**Profile Editing:** Waveforms with any sampling rates are digitally resampled, re-scaled, filtered, and different compensation techniques may be applied to edit the profile using the EDM–Waveform Editor tool. Options for cropping, appending and inserting parts of a waveform are also provided

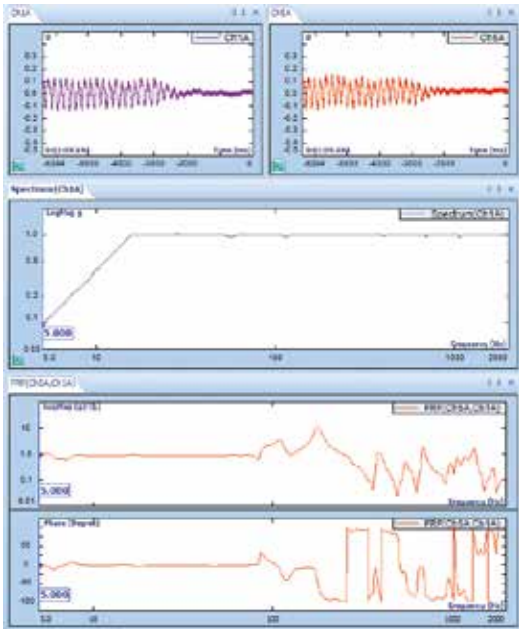

### Real-time Sine Reduction

Real-time sine reduction offers a solution to extend the number of measurement channels of a vibration controller system in a swept sine test. This software is run by a Spider system while an independent vibration controller controls the shaker. The sine reduction application calculates the same time and frequency functions as the controller, but using its own input signals. This function requires a COLA signal from the vibration controller system for instantaneous frequency, phase detection, and spectrum analysis.



### Data Transfer Tool

The Data Transfer Tool is installed with EDM. It transfers all EDM databases (including tests, parameters, and saved files) from a local computer to another over LAN or storage media (e.g. flash drive, DVD, ...). In addition, databases can be transferred between SQL server instances. The transfer and receive process can also be treated as a backup and recovery process. The step-by-step wizard guides the user through the whole process.



### Sensor Calibration

The Sensor Calibration tool is used to calculate the sensitivity of sensors while the measurements of the sensors are compared against referenced sine-wave input signals. The user enters the following information: calibration signal nominal frequency, either RMS reading or dB RMS, and a reference (0 dB) value. The front-end automatically calculates the RMS levels and updates the sensitivity table. The user accepts or rejects the calibration results and views the reports.



### Versatile Report Functions

The EDM software generates test reports from pre-defined templates. Users can customize the logo, margins, orientation of the paper, font formats, and contents of the test reports. The reports can export as OpenXML, PDF, or Microsoft Word file types for convenient usage. A word processing program does not need to be installed in order to create reports. With ActiveX reporting, signal displays in the report can be rescaled, analyzed, and zoomed.

- Users can select from various templates for creating reports
- Plot reports can be generated by simply right-clicking the mouse
- Company logos can be inserted into the template header or footer
- Reports can export as WORD, OpenXML or PDF format
- “Active Report” allows the user to ZOOM in and out like a graph on the report
- Generate typical hardware calibration reports

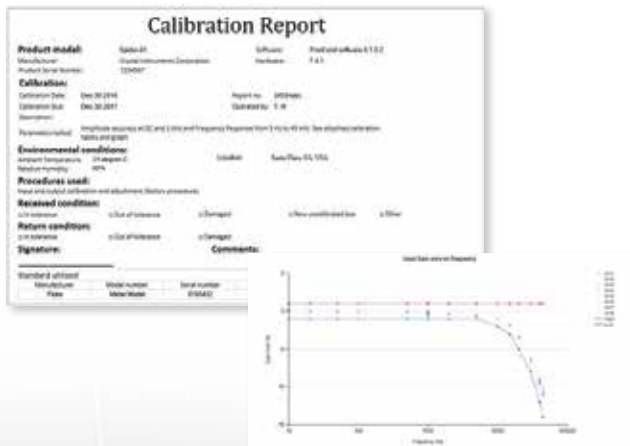

### Front-End Calibration Tool (FECT)

All products are calibrated at the factory prior to shipping and should be recalibrated annually by a factory authorized calibration service. The optional calibration tool existing before EDM 6.1 release is replaced by FECT, which provides a basic adjustment and is operable by the user or a calibration specialist. Reports can be generated from EDM or FECT.

For a more comprehensive calibration report, which provides as found and as left data measured at different frequencies, contact Crystal Instruments or an authorized calibration service provider for more information.



# Multi-Shaker Control

[www.crystalinstruments.com/multiple-shaker-control-software](http://www.crystalinstruments.com/multiple-shaker-control-software)

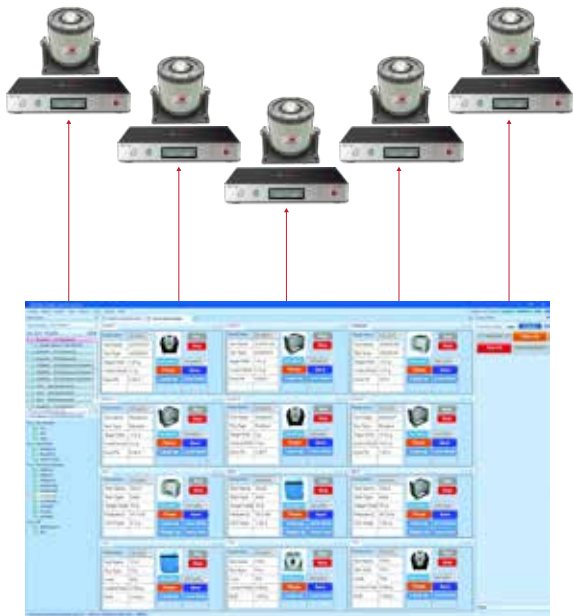

## Multi-Shaker Control from One Application

The EDM MSC function enables users to view and monitor multiple shaker tests from one PC station. The user can observe the testing status, view individual signals from different shaker systems, and send commands to each controller from one centralized application. The MSC feature is especially useful for production applications, increasing efficiency and simplifying control process. For practical reasons we limit the number of controllers that EDM can access to 12.

## Run Different Type of Tests

Different types of tests can be mixed and loaded into this application together. Random, Sine, etc. can run in the same test duration. The status display for each individual shaker controller can be customized. For example, users can display the Peak value for a Sine controller and the RMS value for the random. Users can also show the composite view for one test and show test status view for another test.

## Customizable Individual Command Panel

Commands for each controller are customized. Some panels can have Start/Stop/Pause, and other panels can show Sweep Up/Down. Users can add/remove testing related command item, such as Increase Level, Reset Average, etc.

## Common Commands

Several common commands have been implemented – these commands can be applied to all controllers at once from the main control panel. All the tests can be started or stopped by pressing one button.

## Robust Tolerant Design

Robust software design allows for tests to be run without being interrupted by the failure for other tests. If one test failed for any reason, the other tests will continue, until the operator wants to stop them.

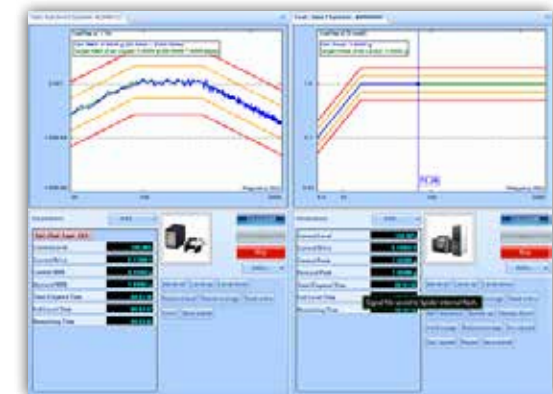

## Online Visualization

[www.crystallinstruments.com/vibration-visualization](http://www.crystallinstruments.com/vibration-visualization)

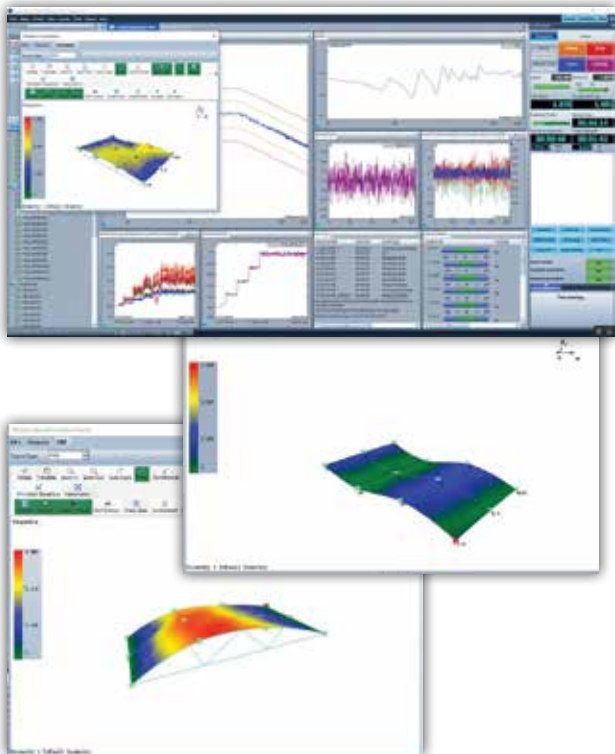
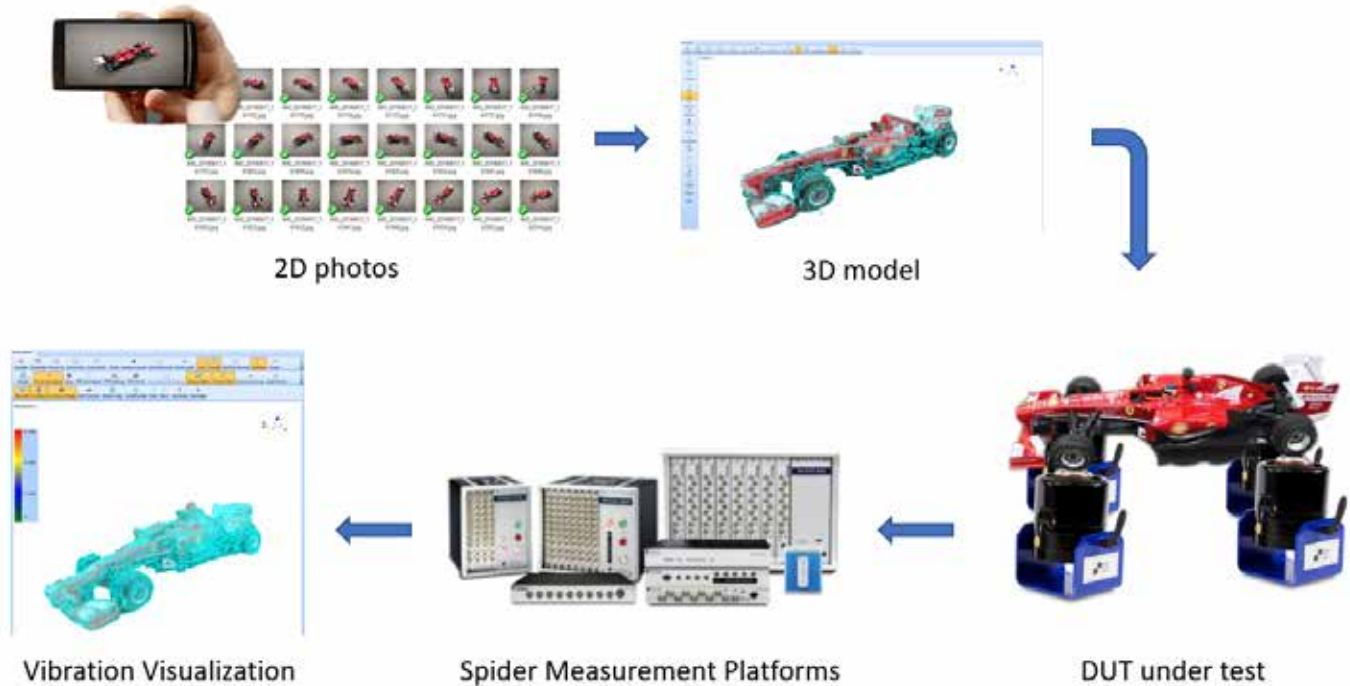

The EDM Online Visualization feature is available in **all test types of EDM VCS software**. This option provides fast and efficient structural model generation and full 3D visualization of the online vibration pattern on the structure under test. There are three tabs to cover the geometry model editing, input channel DOF mapping, and operational deformation shape animation.

The first tab (**Editor**) is designed to help users create the geometric models for viewing the operational deflection shapes of the test structure. The geometric model can be generated with tools built-in to the editor, or imported from a FEA/CAD mode, or imported from the 3D model reconstruction software included in EDM. The 3D model reconstruction software generates a 3D geometry model from a sequence of photos taken around the object. The second tab (**Channels**) allows the user to assign the corresponding DOF information to each enabled input channel. The third tab (**Animation**) displays the deformation animation of the operational deflection shapes of the structure under test. The online visualization feature can use either **Block** or **RMS** data from the input channels to animate the deformation experienced by the test structure at sensor locations. The block data is useful for a more instantaneous display of vibration visualization of the structure under test. The RMS option displays the RMS data of each time block and is more useful to observe which measurement points have maximum or minimum deformation.

# Comprehensive Technology Service Agreement

[www.crystallinstruments.com/technology-service-agreement](http://www.crystallinstruments.com/technology-service-agreement)

Crystal Instruments understands the enormous investment our clients put into our products. We match their investment by offering the most comprehensive technical support agreement in the industry. From support calls to staff training, Crystal Instruments provides solutions to our customers' needs.

The "Comprehensive Technology Support Agreement" offered by Crystal Instruments is fairly priced as a small percentage of the total purchase value. The services offered and included in the agreement are for the duration of 1 year. The agreement is renewable at a locked in rate as a subscription. Rates are subject to increase if a subscription is not continued at the time of renewal and signed up for at a later time. Please contact Crystal Instruments for pricing information.

Services offered are:

- Annual software upgrade program - accessible by convenient online downloads
- Annual hardware calibration
- Priority phone/email/live video support from highly trained engineers
- Temporary replacement unit for hardware in 48 hours
- Data recovering services
- Hardware repair when the total service hours required is less than 4 hours per incident

## Annual Hardware Calibration

Crystal Instruments DMS is certified by ISO:9001. Hardware calibrations are also performed at the customer's site upon request. Customers with a Premier Technology Service Agreement will receive standard annual hardware calibration services at no additional cost (a \$1500 value).

## Annual Software Upgrades

Crystal Instruments provides convenient solutions for software upgrades. Users are able to download the latest versions of Crystal Instruments' Engineering Data Management (EDM) software through the support website.

To find a distributor near you, please visit our website:

Crystal Instruments  
2370 Owen Street  
Santa Clara, CA 95054 (USA)

Phone: +1-408-986-8880  
Fax: +1-408-834-7818

[info@go-ci.com](mailto:info@go-ci.com)  
[www.crystallinstruments.com](http://www.crystallinstruments.com)

Other options include emailed links to download software updates, physical CD-ROMs sent to your location, and installation instructions provided over the phone by our highly qualified Applications Engineers. Customers with a Premier Technology Service Agreement will receive standard software update services at no additional cost.

## Temporary Replacement Units

Crystal Instruments strives to minimize any inconvenience to our customers' operations. Temporary replacement units are often provided to customers as a solution. Units will usually be assigned to customers within 48 hours or less.

## Live Product Support

Crystal Instruments support staff is based in Santa Clara, CA at our corporate headquarters. Our support staff provides phone and email support from 8am to 5pm PST, Monday through Friday. All support is provided by highly trained engineers, not technicians. After hours support is also available upon request.

Crystal Instruments' highly diverse staff provides native language support in English, Spanish, Mandarin, Cantonese, Japanese, Taiwanese, Persian, Hindi, and Vietnamese.

## Hardware Repair Services

Crystal Instruments provides hardware repair for units estimated to have a 4 hour or less repair service period. Additional hours required for repairs are charged at an hourly rate. Replacement parts are discounted by 30% under the Premier Technology Support Agreement. All hardware repair takes place at Crystal Instruments headquarters in Santa Clara, CA. Our highly trained technicians will accurately and efficiently repair your equipment in our ISO:9001 certified facilities.

## Data Recovery Services

Crystal Instruments understands the importance of recovering any lost data safely and securely. Our staff is ready and available to assist you through any data loss crisis.